

ISO9001: 2000
KSA9001: 2001

0575 / EC-TYPE
CE-MARK

15PPM BILGE SEPARATOR

IMO Resolution MEPC. 107(49). Approved Type



巨林 ENGINEERING CO.,LTD.
GEORIM ENGINEERING CO.,LTD.

COMPANY INTRODUCTION

As leading of Oily Bilge Separator(15PPM Bilge Separator) Manufacturer, **GeoRim (巨林, GRS)** has progressed in a professional manufacturer of Oily Bilge Separator, 15ppm Bilge Alarm, Bilge and Sludge Pump, and F.W.(or S.W.) Hydrophore Tank Unit.

Our new type 15PPM Bilge Separator has IMO type approval certificate and EC type certificate and ABS Classification Design Assessment Certificate in accordance with New IMO Resolution MEPC.107(49).

COMPANY HISTORY

- Jul. 1989** Established GeoRim Engineering.
Ship's machinery and equipment section agent of Kolon Engineering Co.,Ltd.
- Oct. 1994** Developed Oil Filtering Equipment in accordance with IMO Resolution MEPC. 60(33).
(TYPE : UST-02G/03G/05G/10G/20NG/50NG/100NG)
- Jan. 1996** Developed Oil Filtering Equipment in accordance with IMO Resolution MEPC. 60(33).
(TYPE : POS-2000,5000)
- Jan. 2000** Developed Oil Filtering Equipment in accordance with IMO Resolution MEPC. 60(33).
(TYPE : POS-N2, POS-N5, POS-N10)
- Jan. 2000** Acquired ISO 9002 & EC Type Certificate from DNV(Det Norske Veritas).
- Jan. 2000** Moved Factory & Head Office from Eomgung Dong to Noksan National Industrial complex (72B9L, 1,650m²).
Changed company name from GeoRim Engineering to GeoRim Engineering Co., Ltd.
- Jul. 2002** Acquired the type approval certificate from Russian Maritime Register of Shipping.
(TYPE : UST-05G, UST-10G, POS-N2, POS-N5, POS-N10)
- Jan. 2003** Acquired ISO-9001:2000/KS A 9001:2001 Certificate from DNV.
- Jun. 2003** Developed 15ppm Bilge Alarm in accordance with IMO Resolution MEPC. 60(33).
- Nov. 2004** Developed new type oily bilge separator, and acquired IMO type approval certificate for 15ppm Bilge Separator in accordance with IMO Resolution MEPC. 107(49).
(TYPE : GRS-02EB, 03EB, 05EB / GRS-10EB, 20EB, 25EB, 50EB, 100EB)
- Jul. 2005** Developed new 15PPM Bilge Alarm, and acquired IMO type approval certificate for 15ppm Bilge Alarm in accordance with IMO Resolution MEPC. 107(49).
- Jul. 2005** Acquired EC TYPE Certificate for 15PPM Bilge Separator in accordance with IMO Resolution MEPC. 107(49). from DNV.

CONTENTS

15PPM BILGE SEPARATOR (GRS-10EB,20EB,25EB,50EB,100EB)	4/5
15PPM BILGE SEPARATOR (GRS-02EB,03EB,05EB)	6/7
PIPING & INSTALLTION	8/9
15PPM BILGE ALARM	10
HYDROPHORE TANK UNIT / PRE-TREATMENT UNIT	11
BILGE PUMP	12
O.L.D (Oil Level Detector) / SLUDGE PUMP	13
OUR PRODUCT RANGE	14/15

PRODUCTS

- 15 PPM BILGE SEPARATOR (IMO TYPE EC-TYPE / MED-CERT)
- 15 PPM BILGE ALARM (IMO TYPE)
- PRE-TREATMENT UNIT FOR OILY BILGE SEPARATOR
- COALESCER FILTER
- PISTON TYPE PUMP (BILGE PUMP)
- SINGLE SCREW PUMP / MONO TYPE
- SPARE PARTS, REPAIR & A/S
- HOT WATER CALORIFIER
- HYDROPHORE UNIT
- SEWAGE TREATMENT EQUIPMENT



15PPM BILGE SEPARATOR

TYPE : GRS-10EB,20EB,25EB,50EB,100EB

1. Tested According , IMO Resolution MEPC. 107(49).
2. Selfcleaing System with Automatic Backwashing

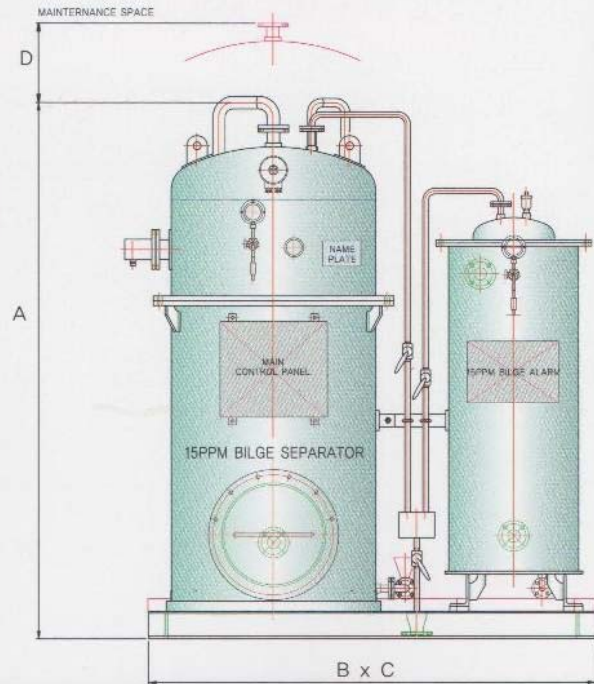

MODEL	CAPACITY	A	B	C	D	INLET	OUTLET	OIL OUTLET	WEIGHT(kg)	
									EMPTY	FULL
GRS-10EB	1.0M ³ /HR	1,820	1,200	880	300	25A	25A	20A	700	1,300
GRS-20EB	2.0M ³ /HR	2,030	1,500	1,000	300	25A	25A	25A	950	1,520
GRS-25EB	2.5M ³ /HR	2,130	1,500	1,000	300	25A	25A	25A	1,050	1,700
GRS-50EB	5.0M ³ /HR	2,100	1,750	1,200	300	40A	40A	25A	1,500	2,370
GRS-100EB	10.0M ³ /HR	2,320	2,050	1,500	300	50A	40A	25A	1,965	3,765

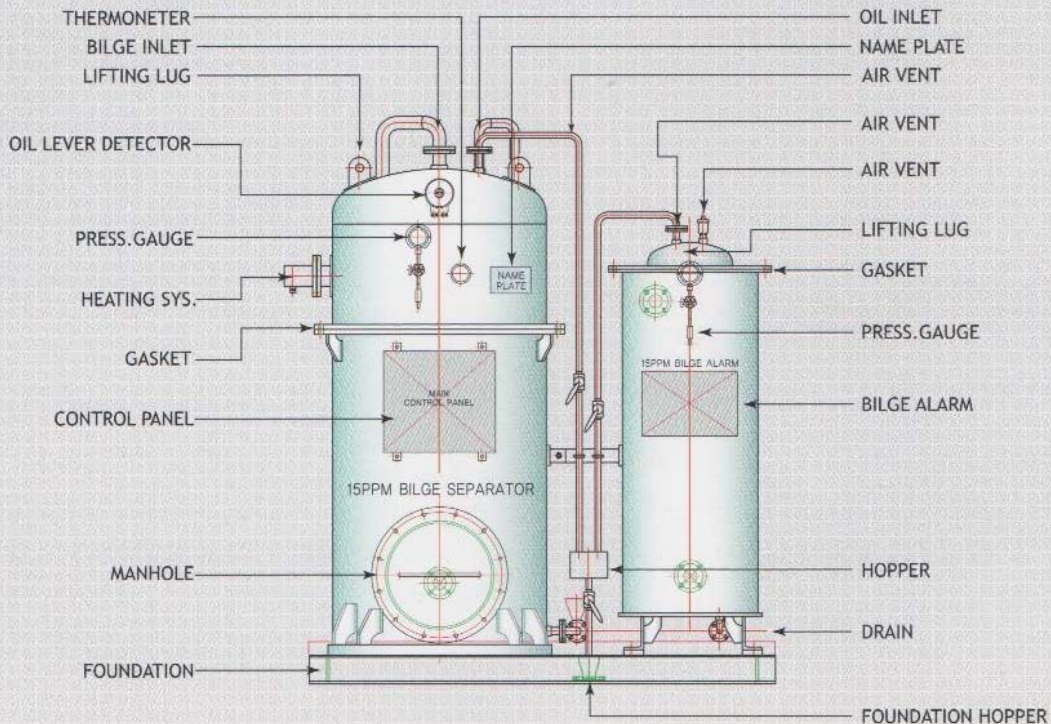

WORKING PRINCIPLE

Fig. 1 SEPARATION OF OIL AND WATER

THE GRS-TYPE 15PPM Bilge Separator separates oil and water by difference of their specific gravity.

The oily water is commenced to be separated when passing 4-way distributing device, and the floated and accumulated oil are collecting into the upper part of 1st chamber of the 1st vessel and also the remains including minute oil particles of oily water passes through the palling & Urethane Coalescer equipped in the 2nd chamber of the 1st vessel. During this process, the size of oily particle become great and floating speed of the particles are increased, thus the oil floats easily. As the emulsified oil is removed by Coalescer equipped in the 3rd chamber of the 1st vessel and 2nd vessel (Emulsion Treatment Unit) and then water is discharged under the condition of below 15PPM (or 5PPM) of oil density.

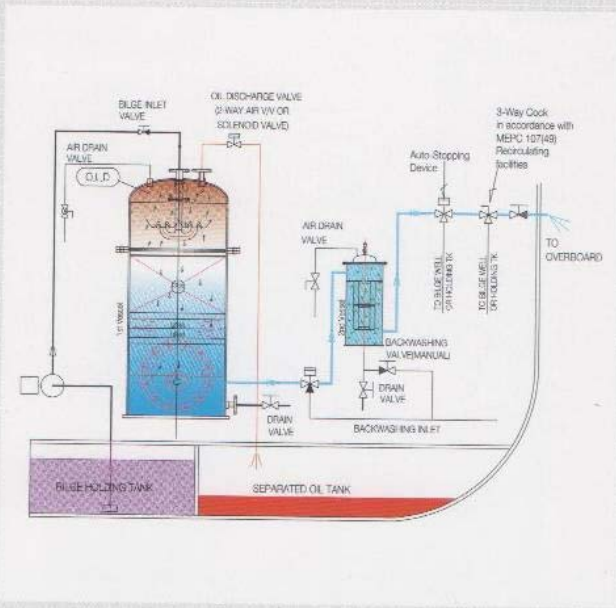

Fig. 2 OIL DISCHARGE

When the collected oil in the upper part of the 1st chamber is detected by the Oil Level Detector, the oil discharging valve is opened and then oil is discharged automatically by the Backwashing system.

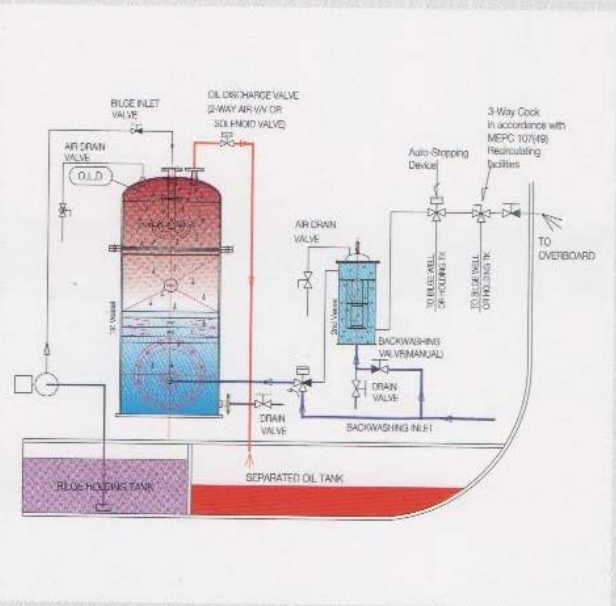

Fig. 3 BACKWASHING

[1st chamber of the 1st vessel]

When the Oil Level Detector detects oil, the bilge pump is stopped and the oil discharge valve is opened and direction of 3-way Backwashing valve is changed for backwashing at the same time. The coalescer filter in the 3rd chamber and Palling & Urethane Coalescer in the 2nd chamber are cleaned by backwashing water automatically, and the floating objects with oil are discharged.

[2nd vessel (Emulsion Treatment Unit)]

The emulsified oil is removed by the Coalescer and the equipment is cleaned by backwashing after opening the Air vent valve with manual Backwashing valve, thus the performance and efficiency of the system are improved.

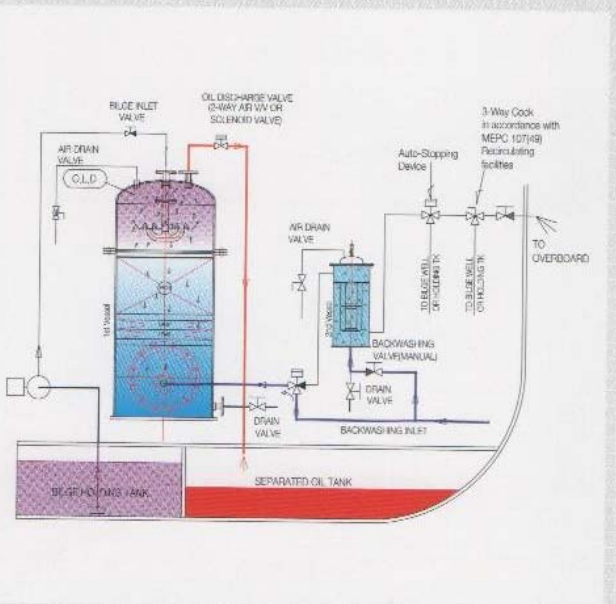

15PPM BILGE SEPARATOR



TYPE : GRS-02EB,03EB,05EB

1. Tested According , IMO Resolution MEPC. 107(49).
2. Selfcleaing System with Manual Backwashing

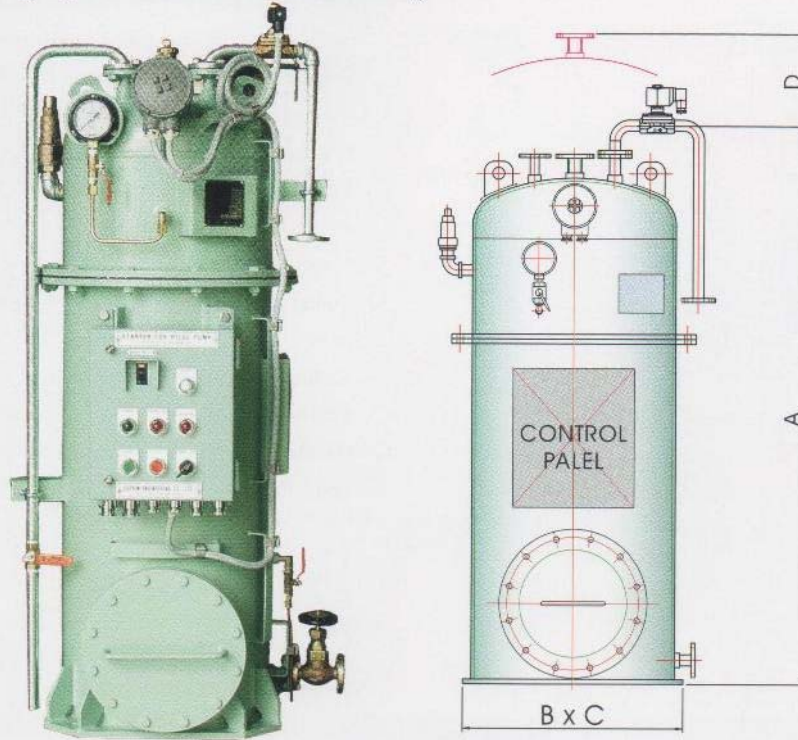

MODEL	CAPACITY	A	B	C	D	INLET	OUTLET	OIL OUTLET	WEIGHT(kg)	
									EMPTY	FULL
GRS-02EB	0.2M ³ /HR	1,170	360	360	200	20A	20A	15A	145	230
GRS-03EB	0.3M ³ /HR	1,320	440	440	200	20A	20A	15A	180	330
GRS-05EB	0.5M ³ /HR	1,390	550	550	200	20A	20A	20A	260	510

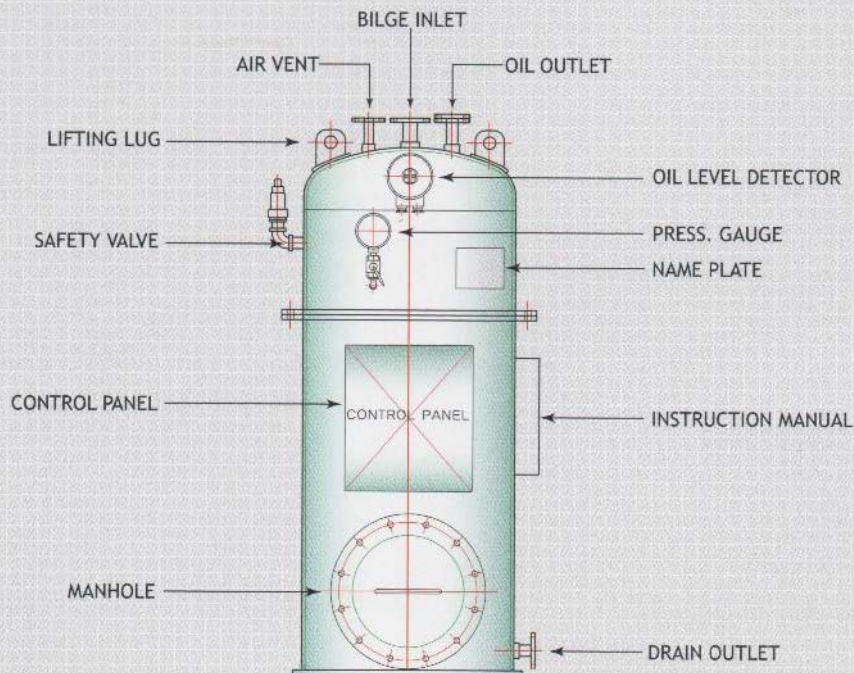

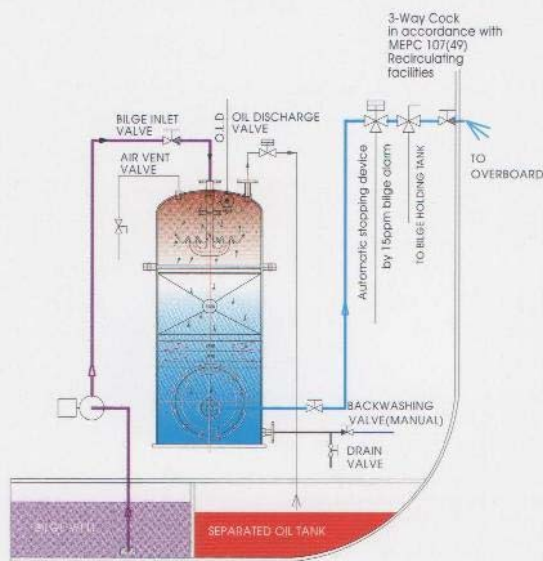

Fig. 1 SEPARATION OF OIL AND WATER

GRS-TYPE 15PPM BILGE SEPARATOR separates oil and water by difference of their specific gravity.

The oily water is commenced to be separated when passing 4-way distributing device, and the floated and accumulated oil are collecting into the upper part of 1st chamber of the 1st vessel and also the remains including minute oil particles of oily water passes through the Pallring & Urethane Coalescer equipped in the 2nd chamber of the 1st vessel.

During this process, the size of oily particle become great and floating speed of the particles are increased, thus the oil floats easily. As the emulsified oil is removed by Coalescer equipped in the 3rd chamber of the 1st vessel and 2nd vessel (Emulsion Treatment Unit), and then water is discharged under the condition of below 15PPM (or 5PPM) of oil density.

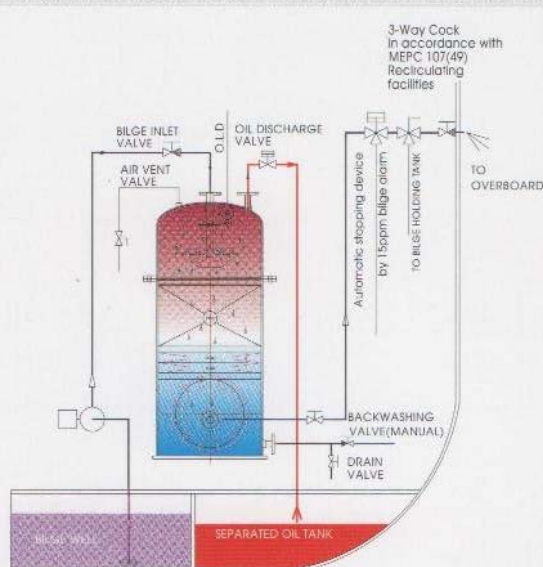

Fig. 2 OIL DISCHARGE

When the collected oil in the upper part of the 1st chamber is detected by the oil level detector, the oil discharge valves is opened and oil is discharged at the same time.

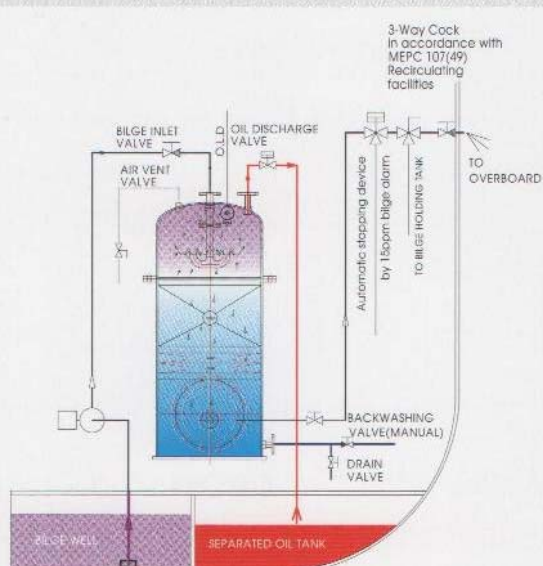
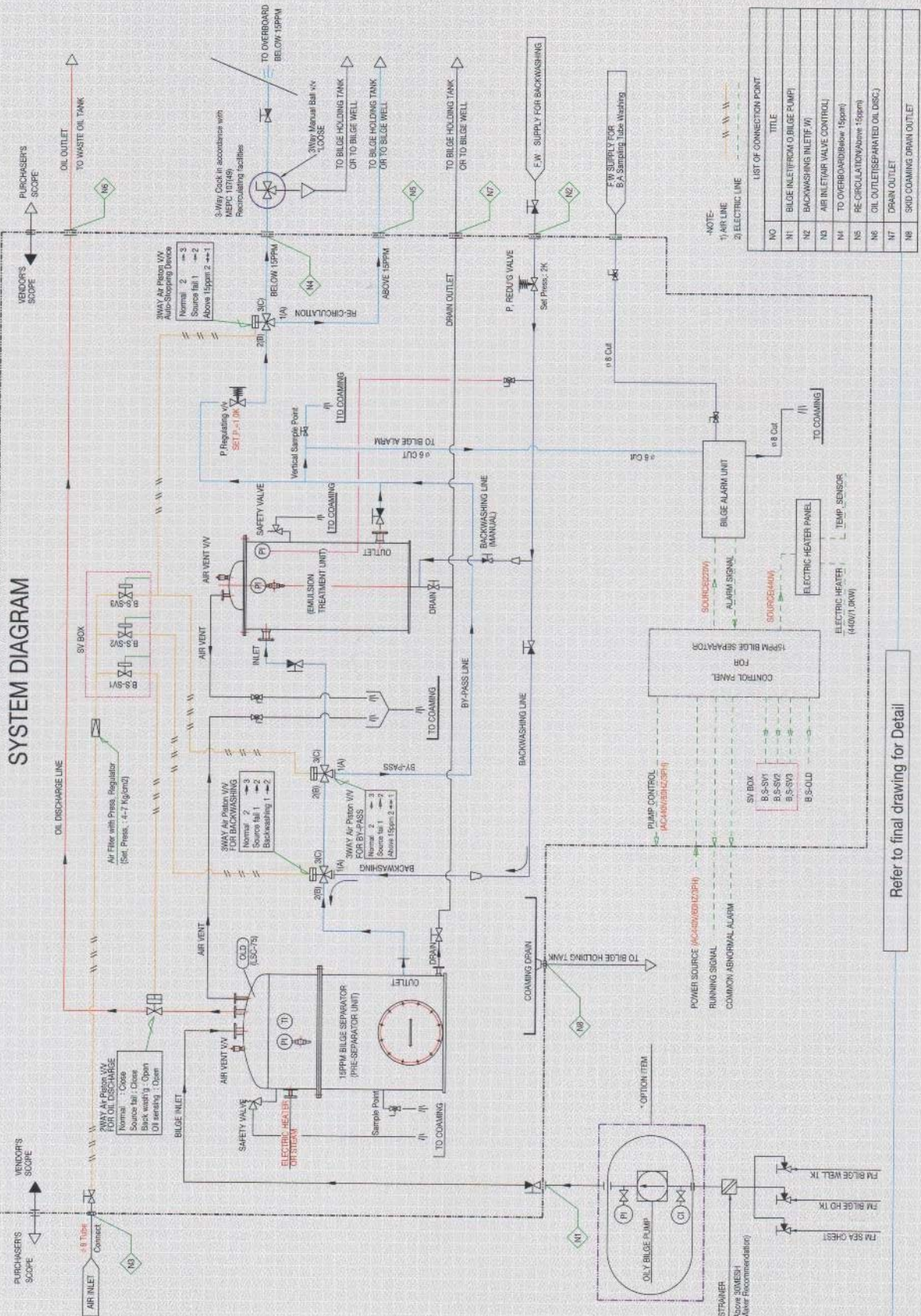

Fig. 3 BACKWASHING

By washing the inside of the equipment after opening the air vent valve and manual backwashing water inlet valve, the coalescer filter in the 3rd chamber and pallring & urethane coalescer in the 2nd chamber are cleaned by Backwashing water. As the result, it's performance and efficiency are maintained by discharging the floating objects and oil in the equipment.

Piping & Installation

(GRS-10EB / 20EB / 25EB / 50EB / 100EB)



Piping & Installation

(GRS-02EB / 03EB / 05EB)

SYSTEM DIAGRAM

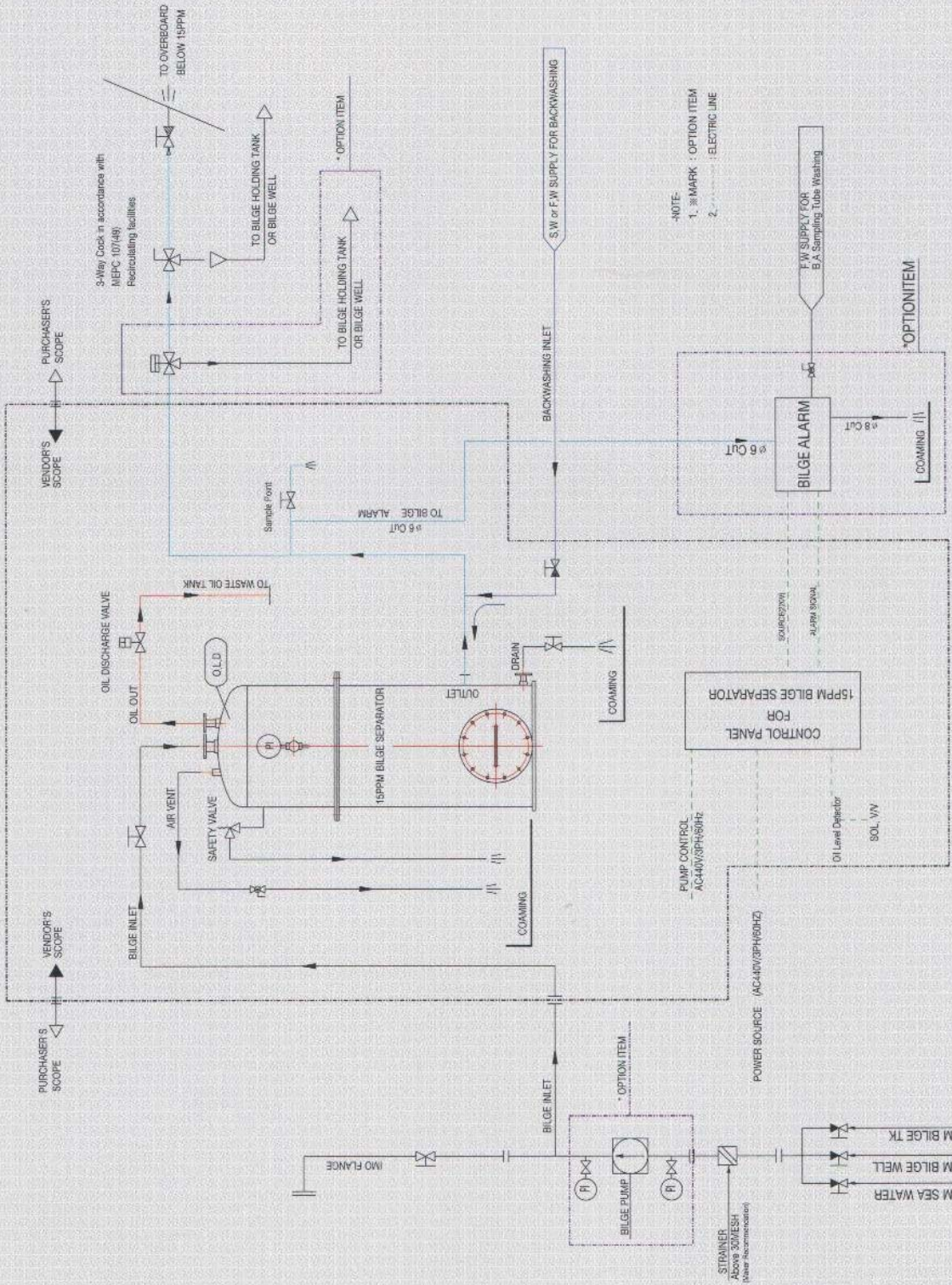

Refer to final drawing for Detail

15PPM BILGE ALARM

TYPE : GBA-155

This 15ppm Bilge Alarm meets the requirements of IMO Resolution MEPC. 107(49). Type-Approval Certificate in according with IMO Resolution MEPC. 107(49). therefore this satisfy international convention.

This 15ppm Bilge Alarm Monitor serves to continuously measure the concentration of oil int bilge and other waste water produced on a ship, and produces an alarm signal when the oil concentration exceeds 15ppm

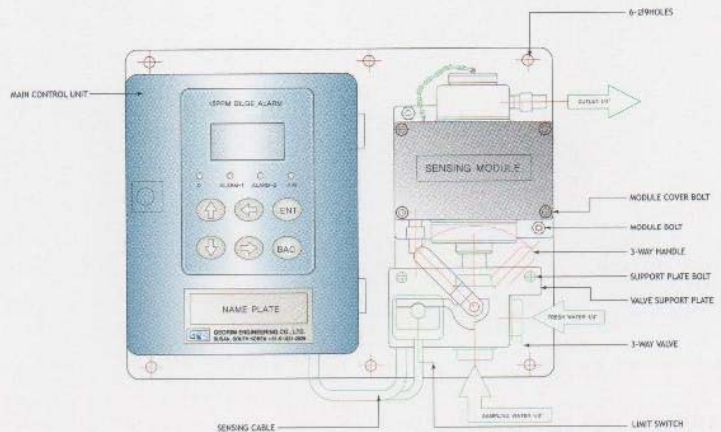

No	ITEM	DESCRIPTION
1	Measuring range	0~30ppm
2	Measuring accuracy	15ppm [±] ±5ppm (IMO Resolution MEPC107(49))
3	Set point	15ppm
4	Response time	Time delay : 0 second(Below 5 sec.)
5	Alarm contacts/Rating	Normal/Alarm contacts
6	Sources of electricity	AC100~220V
7	Dimensions	(w)350 x (L)270 x (H)80
8	Weight	About10kg

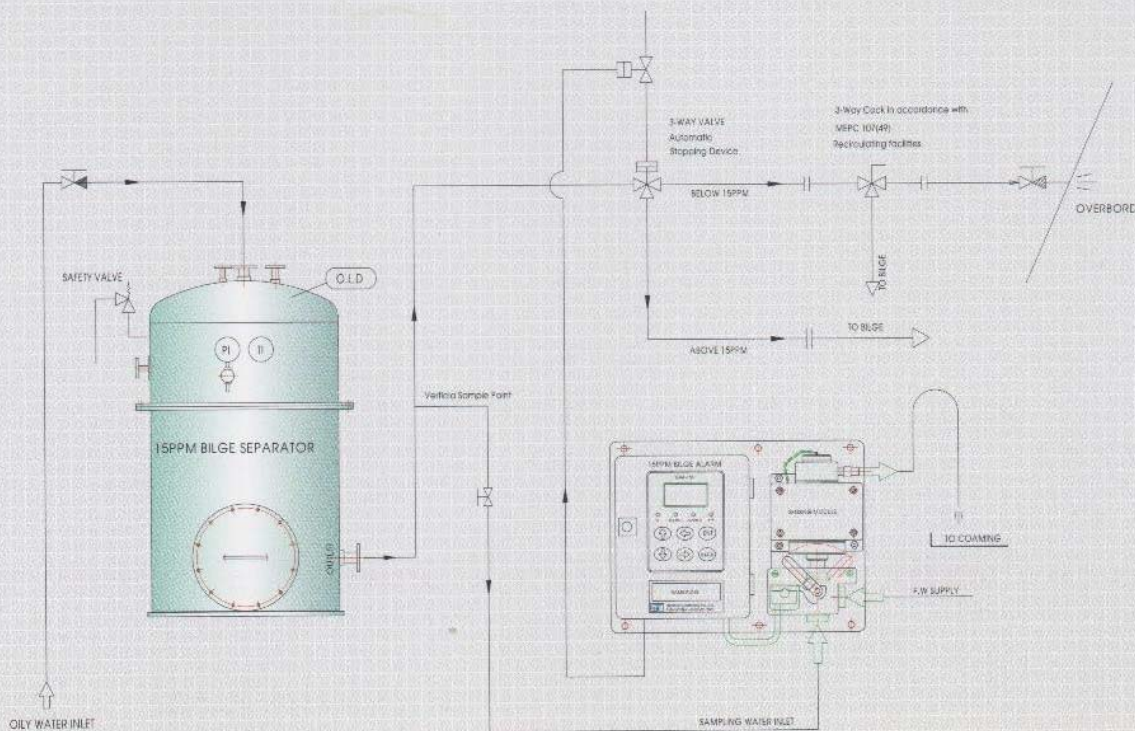

HYDROPHORE TANK UNIT

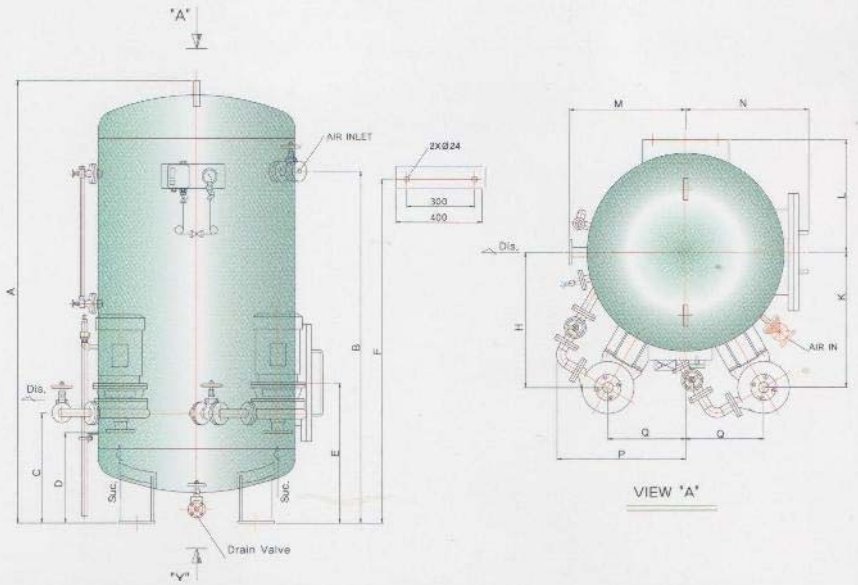

Model No.	Bore		Tank Volume(m ³)	Dimension(mm)									
	Suc.	Dis		A	B	C	D	E	F	G	H	K	L
GRH-0.5-DR	#	40	0.5	1205	805	450	350	600	795	625	590	590	495
GRH-1.0-DR	#	40	1.0	1975	1570	450	350	650	1620	650	625	625	520
GRH-1.5-DR	#	50	1.5	2010	1700	450	350	700	1520	750	710	710	620
GRH-2.0-DR	#	50	2.0	2170	1800	450	350	750	1690	800	825	825	670

PRE - TREATMENT UNIT

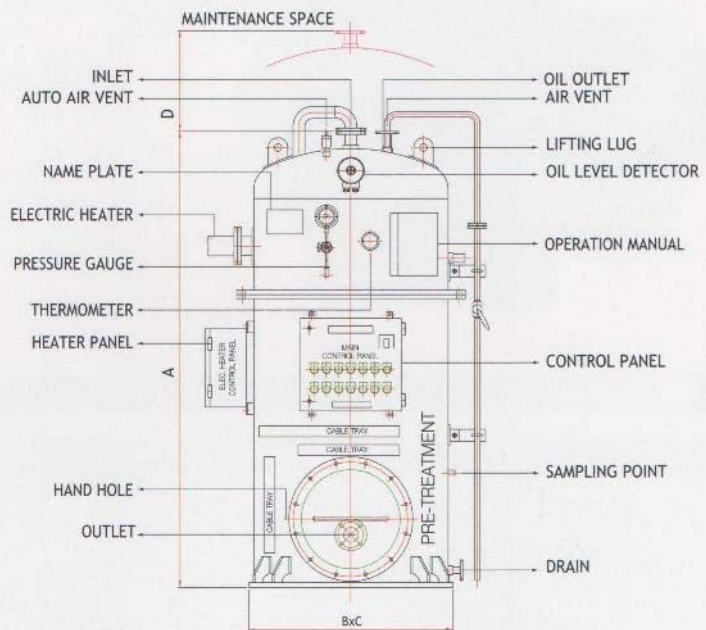

MODEL	CAPACITY	A	B	C	D	INLET	OUTLET	OIL OUT
GRS-20.25N	2.0,2.5M ³ /HR	1,610	700	700	400	JIS5K-25A	JIS5K-25A	JIS5K-25A
GRS-50N	5.0M ³ /HR	1,810	700	700	400	JIS5K-40A	JIS5K-40A	JIS5K-25A
GRS-100N	10.0M ³ /HR	1,870	840	840	400	JIS5K-50A	JIS5K-50A	JIS5K-25A



BILGE PUMP (piston type)

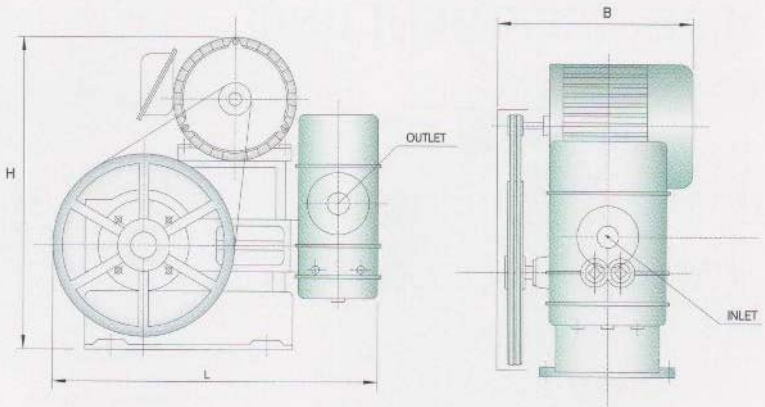

MODEL	UNIT	1015C	1015	1015B	101A	101B	101C	101D	102	103
CAPACITY	m ³ /hr	0.15	0.2	0.3	0.5	1.0	2.0	2.5	5.0	10.0
MOTOR	kw	0.4x4p	0.4x4p	0.4x4p	0.4x4p	0.4x4p	0.75x4p	0.75x4p	1.5x4p	2.2x6p
PUMP	R.P.M	420	420	420	280	280	280	280	220	240
L	mm	510	510	510	450	450	450	450	745	770
B	mm	300	300	300	284	284	284	284	410	430
H	mm	420	420	420	480	480	480	480	570	570
IN/OUTLET	15A5K	15A5K	20A5K	20A5K	25A5K	25A5K	25A5K	25A5K	50A5K	50A5K
WEIGHT	kg	45	45	45	80	80	80	80	168	198

MODEL	GRP15	GRP20	GRP30	GRP40	GRP50	GRP60
CAPACITY	15m ³ /hr	20m ³ /hr	30m ³ /hr	40m ³ /hr	50m ³ /hr	60m ³ /hr

O.L.D (Oil Level Detector)

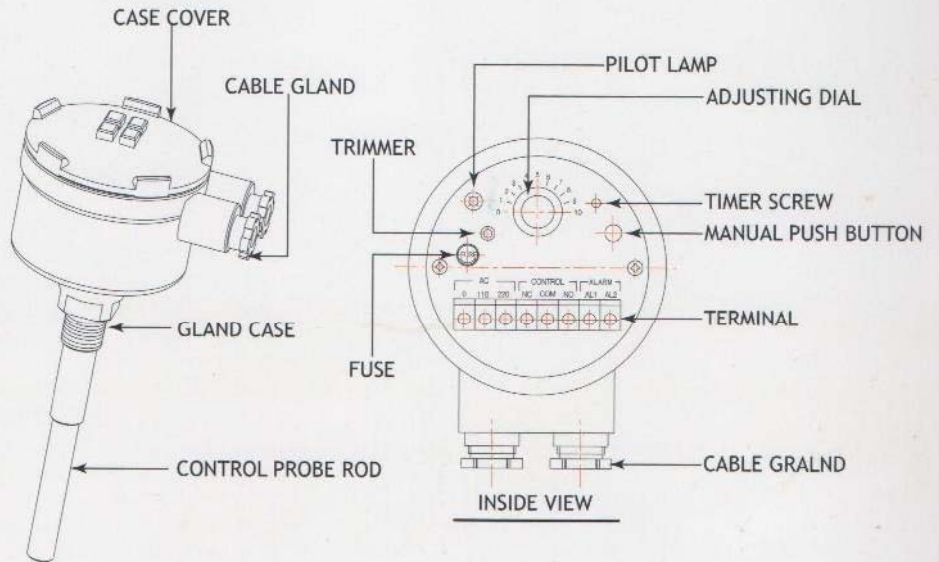

SLUDGE PUMP (Single Screw Pump / mono type)

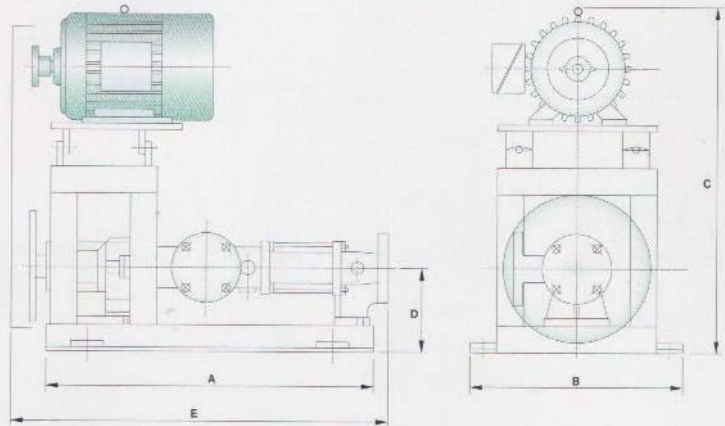
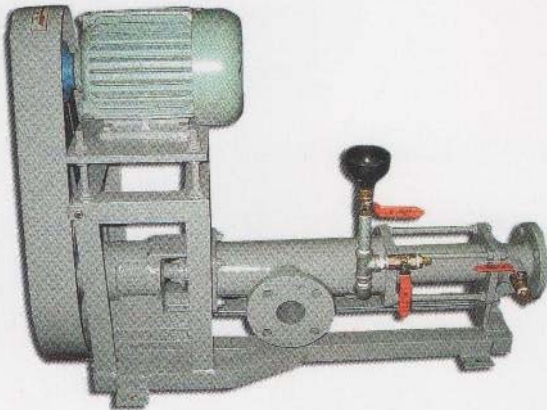

MAX : 200m³/hr

MODEL	UNIT	DRF32-1	DRF40-1	DRF50-1	DRF65-1	DRF80-1
CAPACITY	m ³ /hr	1.0	2.0	3.0	5.0	10.0
MOTOR	Kw	0.75x6p	0.75x6p	1.5x6p	2.2x6p	3.75x6p
PUMP	R.P.M	360	380	350	350	350
A	mm	610	820	850	860	1040
B	mm	410	490	490	490	540
C	mm	630	670	680	710	830
D	mm	160	180	180	190	200
E	mm	750	950	970	1100	1180
IN/OUTLET		32A10K	40A10K	50A10K	65A10K	80A10K
WEIGHT	Kg	80	120	180	270	350

OUR PRODUCT RANGE

15PPM BILGE SEPARATOR

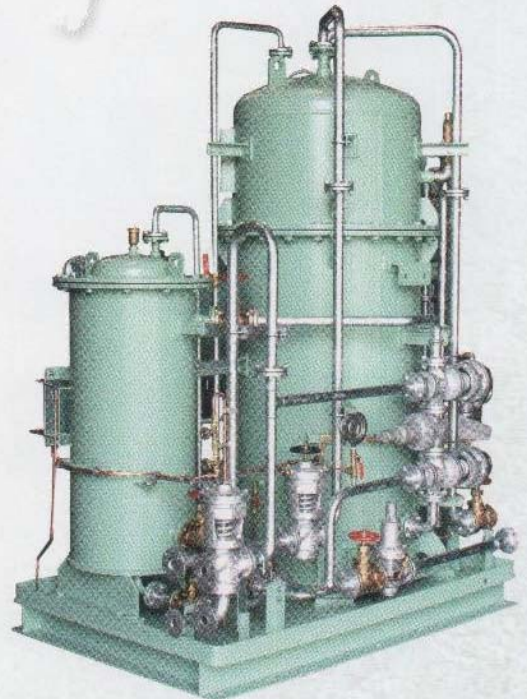
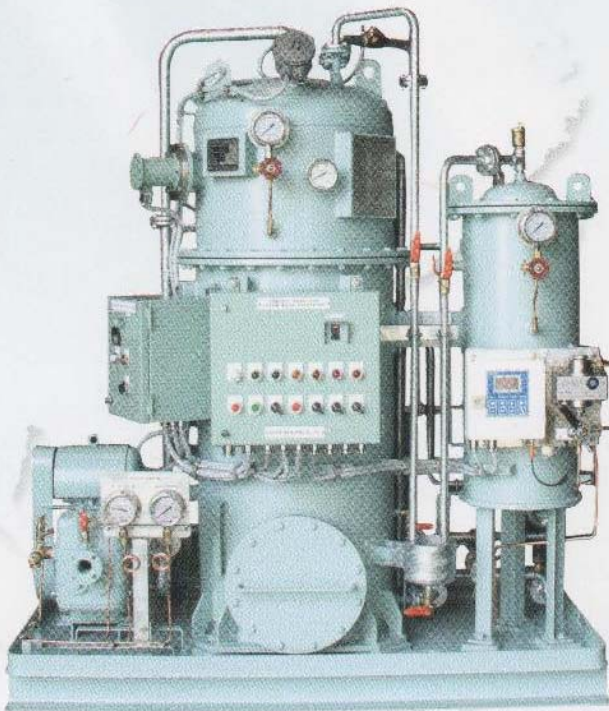
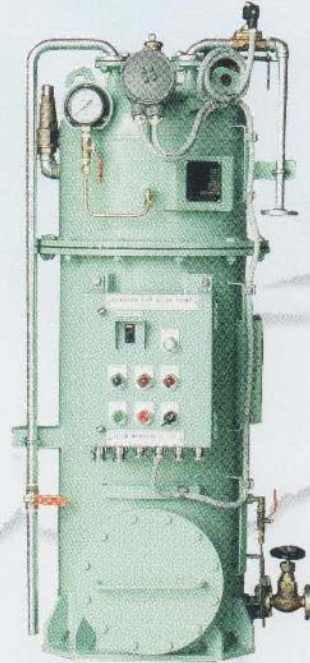
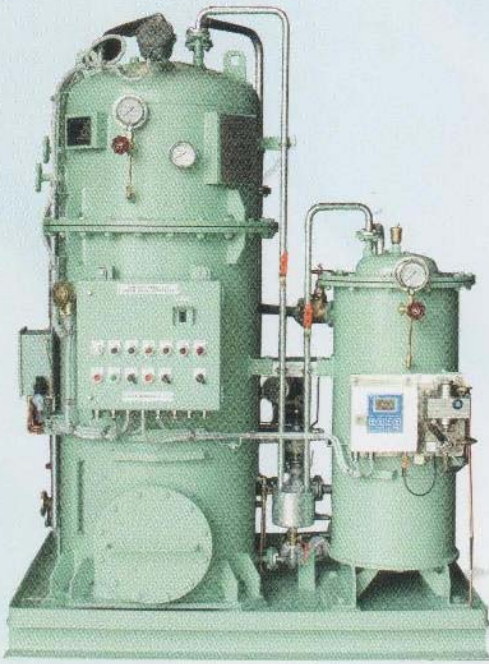

OUR PRODUCT RANGE



▲ Coalescer Filter for 15ppm Bilge Separator



▲ Sewage Treatment Equipment

Bilge Pump

(piston reciprocating type, double acting piston)



▲ Capacity : 0.5~30m³/h



▲ 40, 50, 60m³/h

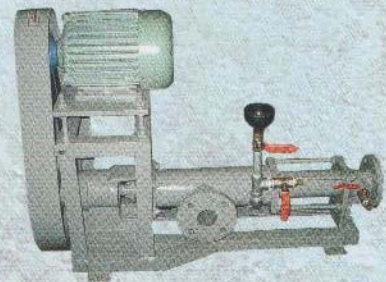

▲ Capacity : 1.0~200 m³/h

Sludge Pump

(single screw, mono pump)



▲ Manual 3-Way Ball Valve

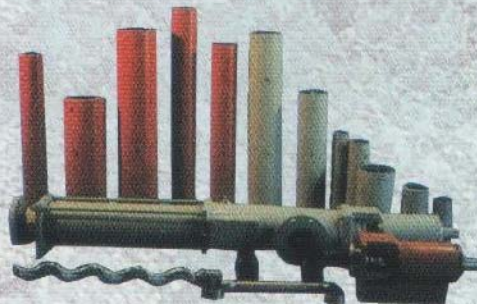

▲ Stator for Pump

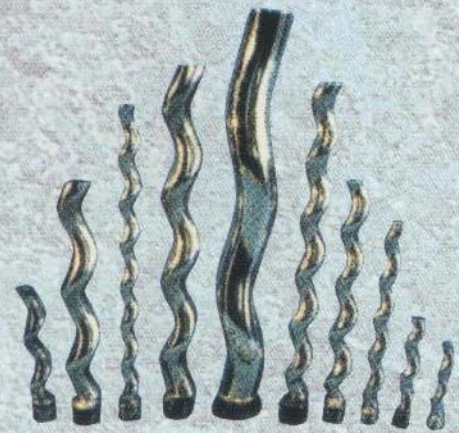

▲ Rotor for Pump